

WT100

VIERKANT WERVELROOSTER MET
INSTELBAAR LUCHTPATROON

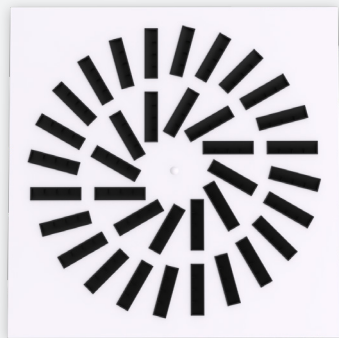

VARIANTEN

WT100_S, WT100_T

Het wervelrooster type WT100 is uitgerust met oriënteerbare kunststof deflectoren. Het is ontworpen voor inleg plafondsyste- men maar kan ook in onderbouw gemon- teerd worden. Door het uitstekend werve- leffect wordt een hoge inductie verkregen. Het rooster heeft een sterk coanda effect over een breed temperatuurbereik (ook bij lage debieten) en is bijgevolg optimaal ge- schikt voor VAV toepassingen.

Instelbaar uitblaaspatroon d.m.v. oriënteerbare deflectoren

Hoge inductie met sterk coanda effect

Optimaal geschikt voor VAV-toepassingen

TOEBEHOREN

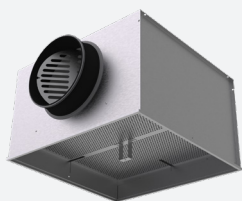

WP100S

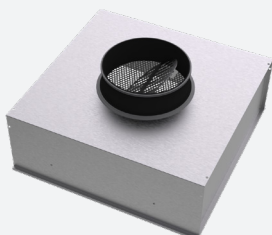

WP100T

TECHNISCHE INFORMATIE

TOEPASSING	Type	Toevoer of afvoer
	Uitblaasrichting	Horizontaal, instelbaar
CONSTRUCTIE	Frontplaat	Centrale schroefbevestiging
	Nominale groottes (aantal deflectoren)	Ø125 (9), 160 (12), 200 (24), 250 (36), 315 (48), 355 (48)mm
	Standaard paneelgroottes	294x294, 394x394, 494x494, 594x594, 819x819mm
MATERIAAL	Standaard materiaal	Frontplaat: gepoederlakt plaatstaal Deflectoren: ABS Plenum: gegalvaniseerde (275g/m ²) staalplaat
	Aansluiting plenum	PP/TPE aansluiting, Klasse D met dubbele lipdichting
	Standaard afwerking	Poederlak in RAL9010
	Afwerkingsopties	Poederlak in RAL-kleur naar keuze
	Optionele isolatie	Melamine 6mm
	Optionele debietregeling	Gegalvaniseerde geperforeerde volumeregelaar met handbediening
MONTAGE	Montage opties	Voorzien van ophangogen (Ø 7 mm), ophangpatten verkrijgbaar op aanvraag

SNELSELECTIETABEL

ØN [mm]	A [mm]	L _w	Toevoer Q _v [m ³ /h]	
			WT100 + WP100S	WT100 + WP100T
125 (9)	294	25 dB(A)	102	123
		35 dB(A)	142	167
160 (12)	394	25 dB(A)	130	129
		35 dB(A)	186	188
200 (24)	494	25 dB(A)	266	260
		35 dB(A)	363	353
250 (36)	594	25 dB(A)	336	353
		35 dB(A)	464	495
315 (48)	594	25 dB(A)	481	462
		35 dB(A)	636	617
355 (48)	819	25 dB(A)	458	524
		35 dB(A)	640	745

EFFECTIEVE DOORLAATOPPERVLAKTE

Toevoer A _k [m ²]	ØN [mm]					
	125 (9)	160 (12)	200 (24)	250 (36)	315 (48)	355 (48)
	0,1520	0,0207	0,0271	0,4560	0,0804	0,0902

BESTELSLEUTEL

VIERKANT WERVELROOSTER MET INSTELBAAR LUCHTPATROON

W	T	1	0	0	-	F	0	2	5	0	0	5	9	4
---	---	---	---	---	---	---	---	---	---	---	---	---	---	---

Nominale grootte ØN (mm):
125, 160, 200, 250, 315, 355

Paneelmaat A (mm):
294, 394, 494, 594, 819

F: Geschilderd

0: Zwarte ABS deflectoren
1: Witte ABS deflectoren
2: Zonder deflectoren (afvoer)

PLENUM VOOR VIERKANT WERVELROOSTER

W	P	1	0	0	S	-	-	0	0	2	5	0	0	5	9	4
---	---	---	---	---	---	---	---	---	---	---	---	---	---	---	---	---

Aansluitdiameter ØD (mm):
125, 160, 200, 250, 315

Plenummaat (mm):
294, 394, 494, 594, 819

0: Plenum zonder ophangpatten
1: Plenum met ophangpatten

-: Zonder volumeregelklep
D: Met volumeregelklep

-: Niet geïsoleerd plenum
G: Geïsoleerd plenum

S: Side aansluiting
T: Top aansluiting

0: Toevoer - met perfo
2: Afvoer - zonder perfo, met beugel voor centrale schroefbevestiging

VIERKANT WERVELROOSTER MET INSTELBAAR LUCHTPATROON MET GEMONTEERD PLENUM

W	T	1	0	0	-	F	S	-	-	0	0	2	5	0	0	5	9	4
---	---	---	---	---	---	---	---	---	---	---	---	---	---	---	---	---	---	---

Nominale grootte ØN
(mm):
125, 160, 200, 250, 315, 355

Paneelmaat A (mm):
294, 394, 494, 594, 819

0: Plenum zonder ophangpatten
1: Plenum met ophangpatten

-: Zonder volumeregelklep
D: Met volumeregelklep

-: Niet geïsoleerd plenum
G: Geïsoleerd plenum

S: Side aansluiting
T: Top aansluiting

F: Geschilderd

0: Zwarte ABS deflectoren
1: Witte ABS deflectoren
2: Zonder deflectoren (afvoer)

125 (9)

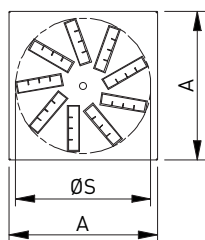

355 (48)

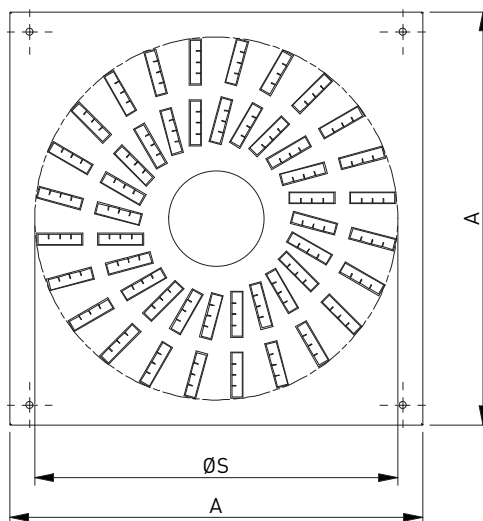

160 (12)

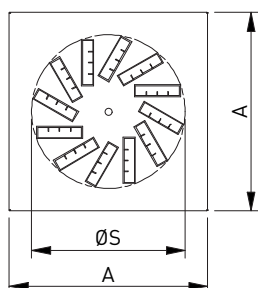

200 (24)

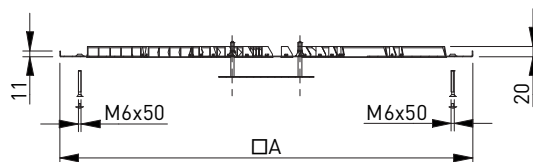
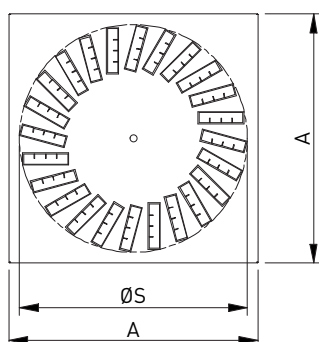

250 (36)

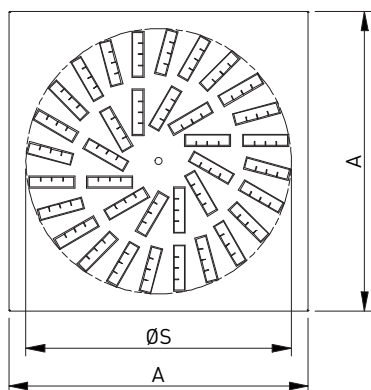

315 (48)

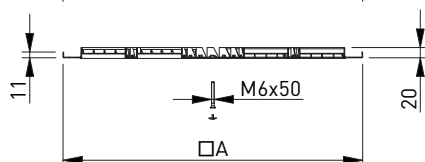
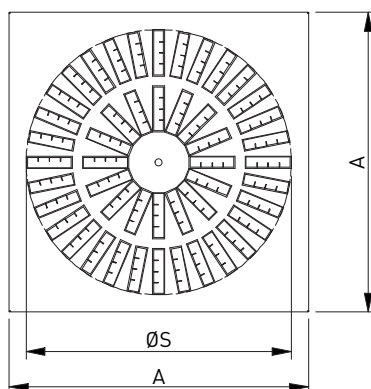

WP100S-D1/125/294

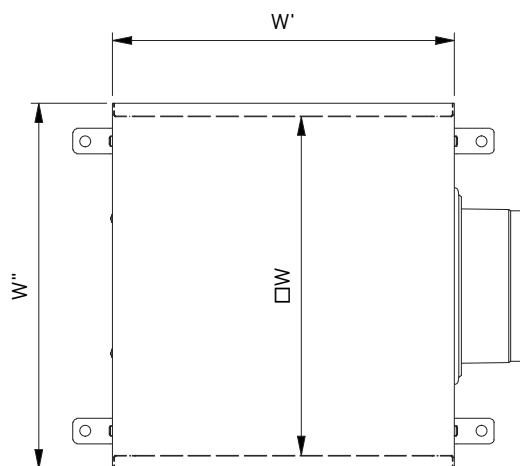
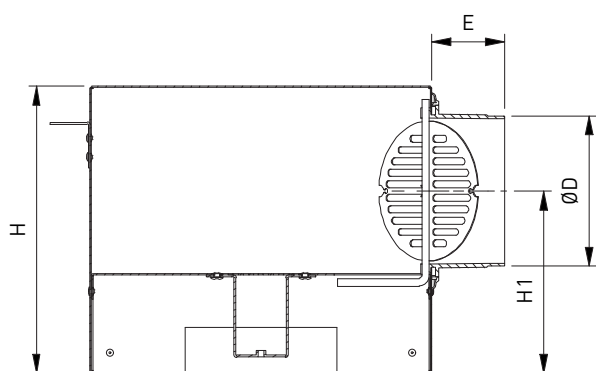

WP100S-D0/160/394
 WP100S-D0/200/494
 WP100S-D0/250/594

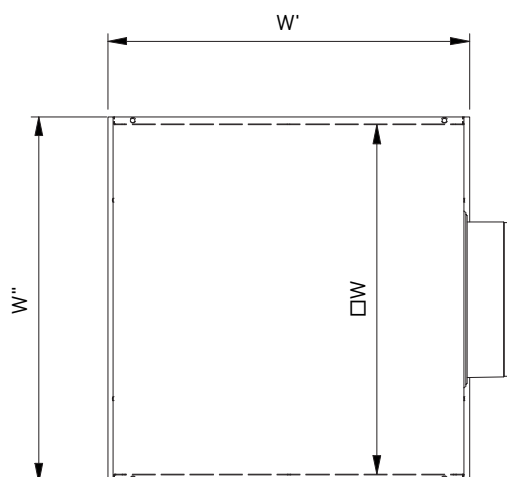
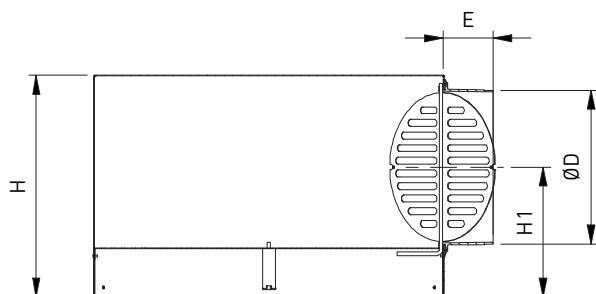

WP100S-D1/315/819

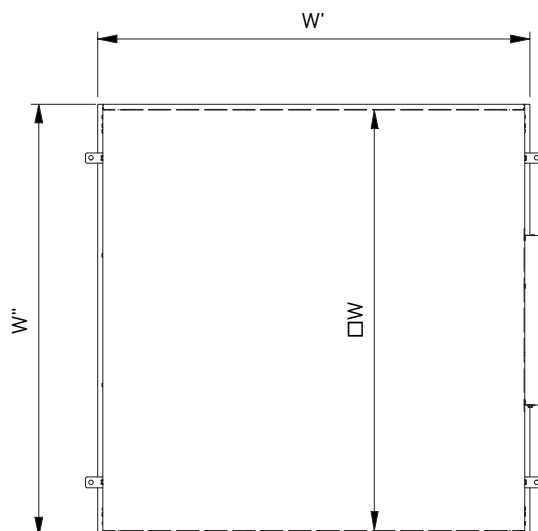
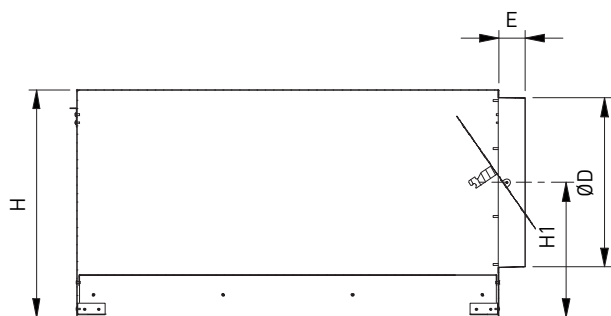

WP100T-D1/125/294

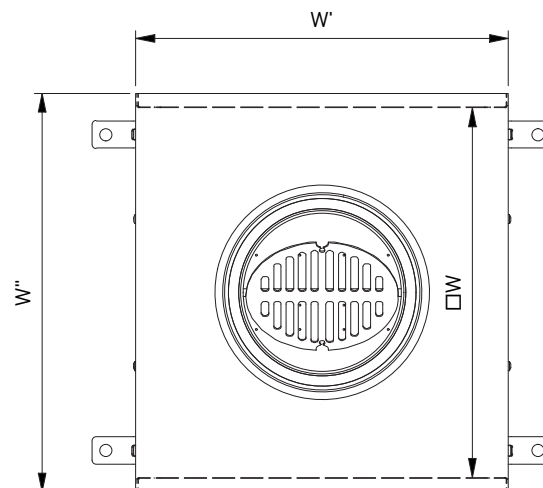
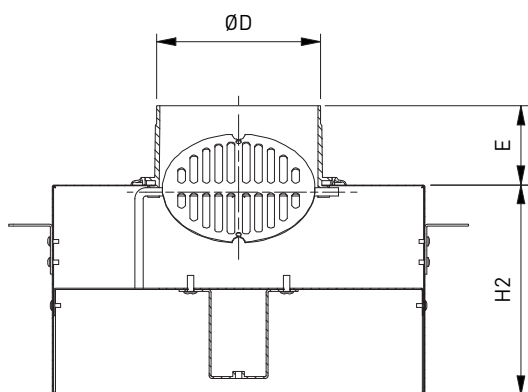

WP100T-D0/160/394
 WP100T-D0/200/494
 WP100T-D0/250/594

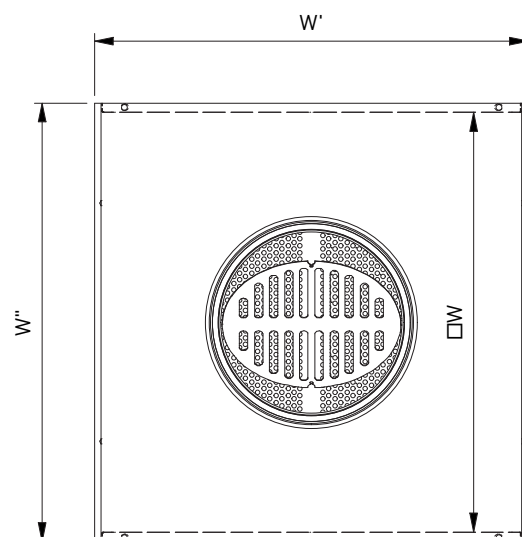
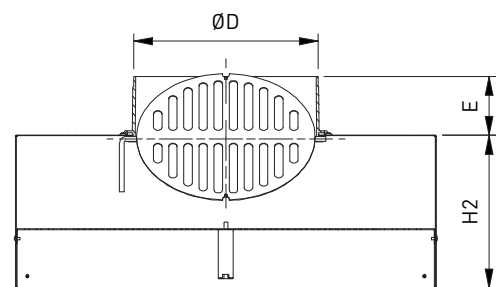

WP100T-D1/315/819

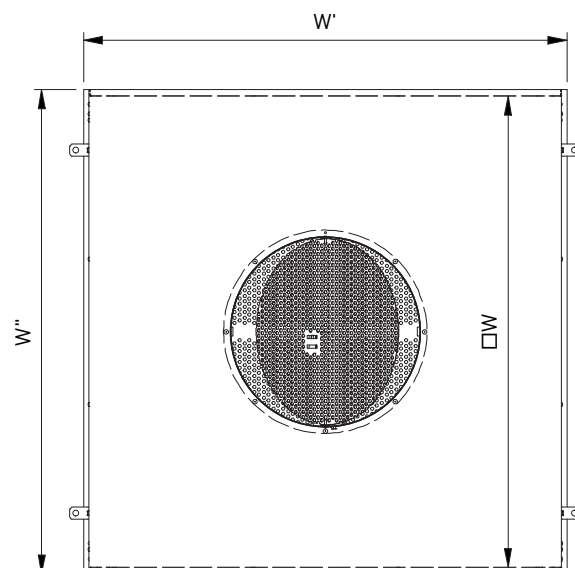
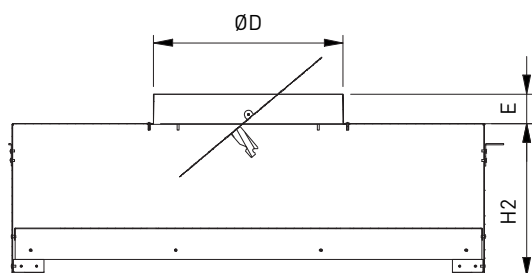

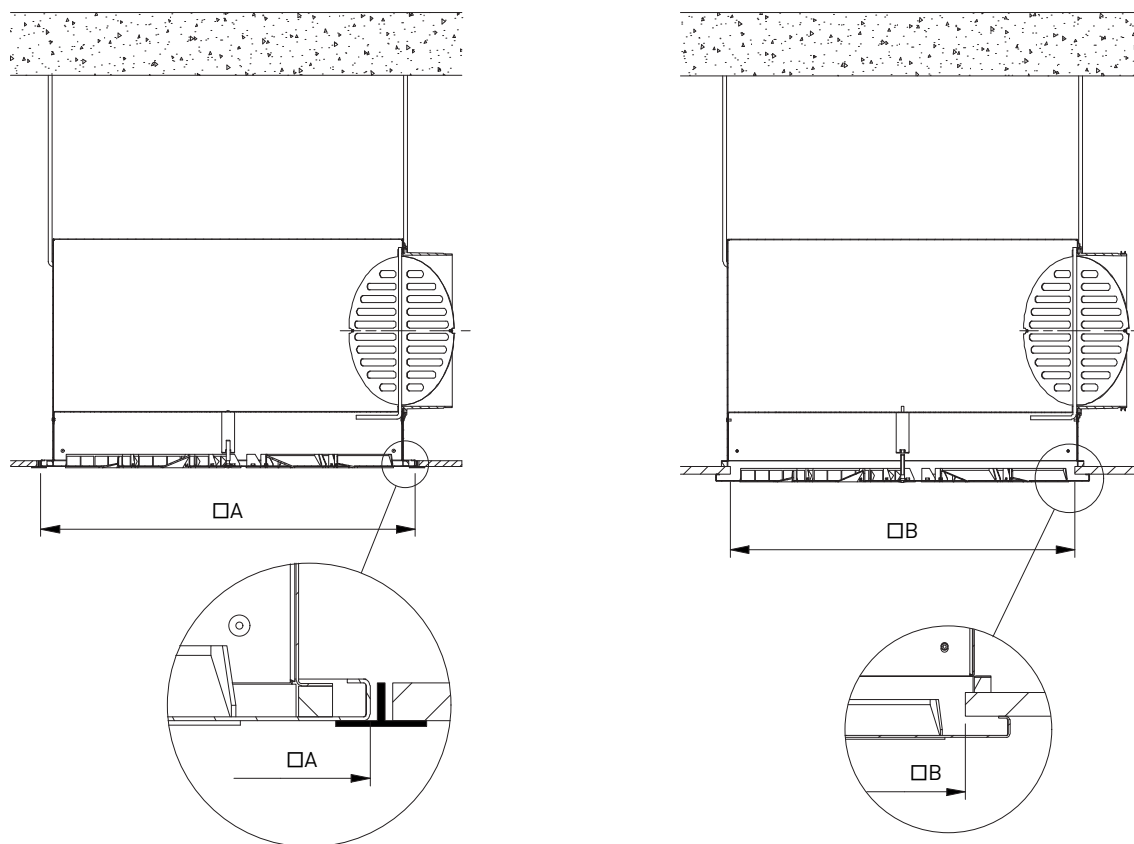

AFMETINGEN

ØN	A	B	ØD	E	H	H1	H2	ØS	W	W' x W''
125 (9)	294	268	125	58	227	145	152	266	269	271 x 290
160 (12)	394	353	160	58	262	162	202	302	356	374 x 381
200 (24)	494	453	200	58	302	182	202	450	456	474 x 481
250 (36)	594	553	250	78	352	207	202	524	555	574 x 580
315 (48)	594	553	250	78	352	207	202	531	555	574 x 580
355 (48)	819	778	315	50	422	245	252	718	775	799 x 800

Alle afmetingen in mm