

# Filters change ROTO K device series

Project: .....

Device: .....

Location: .....

	Device type	Filter type	Filtering class	Product ID	Price in € *
	<b>ROTO K ... H</b>				
<input type="checkbox"/>	ROTO K 1050H / Extract air	LFP 46 M5	M5	137852	96,00
<input type="checkbox"/>	ROTO K 1050H / Outdoor air	LFP 46 F7	F7	137851	156,00
<input type="checkbox"/>	ROTO K 1700H / Extract air	LFP 46 M5	M5	137852	96,00
<input type="checkbox"/>	ROTO K 1700H / Outdoor air	LFP 46 F7	F7	137851	156,00
<input type="checkbox"/>	ROTO K 2800H / Extract air	LFP 48 M5	M5	137854	120,00
<input type="checkbox"/>	ROTO K 2800H / Outdoor air	LFP 48 F7	F7	137853	246,00
<input type="checkbox"/>	ROTO K 4200H / Extract air 2 pieces are needed	LFP 50 M5	M5	138612	94,00
<input type="checkbox"/>	ROTO K 4200H / Outdoor air 2 pieces are needed	LFP 50 F7	F7	138611	184,00
<input type="checkbox"/>	ROTO K 7600H / Extract air 2 pieces are needed	LFP 56 M5	M5	139806	119,00
<input type="checkbox"/>	ROTO K 7600H / Outdoor air 2 pieces are needed	LFP 56 F7	F7	139805	336,00
<input type="checkbox"/>	ROTO K 12600H / Extract air 3 pieces are needed	LFP 62 M5	M5	140635	168,00
<input type="checkbox"/>	ROTO K 12600H / Outdoor air 3 pieces are needed	LFP 62 F7	F7	140637	319,00

\* Stand August 2018

## Filters change

# ROTO K 1050 H, 1700 H, 2800 H, 4200 H, 7600 H, 12600 H

- 1** Switch off the equipment from the remote control unit. Wait until the equipment is switched off completely.

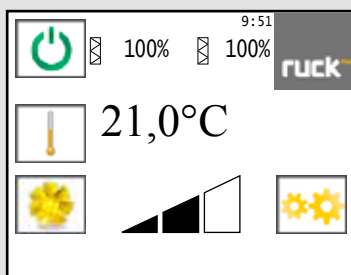

- 2** Unlock doors with the supplied key.

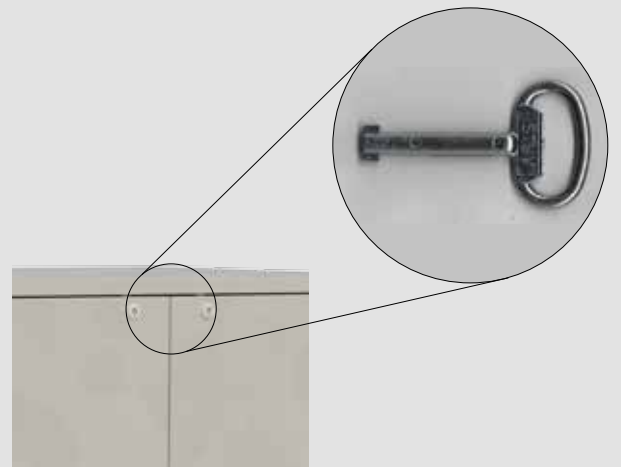

- 3** Open the doors, then pull out the filters clamps.



- 4** The air filters can be pulled out without tools.

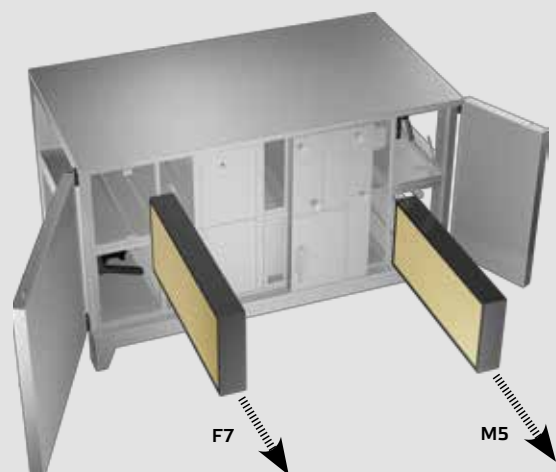

- 5** When changing the filters, pay attention to the correct fit of the filter frame between the guide rails in the unit. Damage to the filter surface must be avoided, otherwise the filter may tear during operation and the filter class is no longer guaranteed.

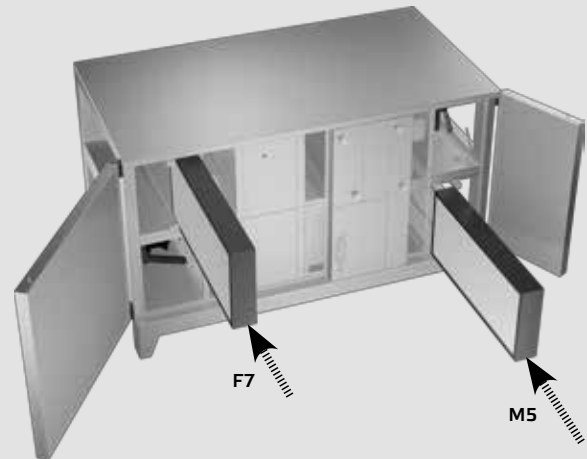

- 6** Push back the filters clamps, then close and lock the doors.



- 7** Switch on the equipment from the remote control unit.

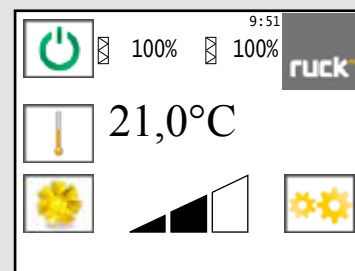

- 8** Calibrate filters

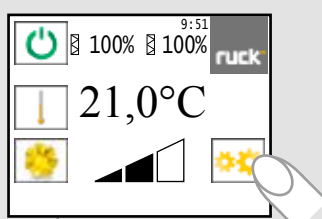

Menu level Operating parameters (qualified personnel)  
You can access the Commissioning level by selecting the „Settings“ icon.  
The display then shows the selection menu.

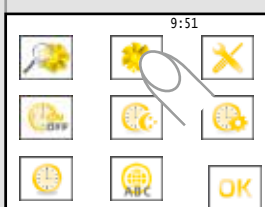

Selection menu  
Now you can access the Operating parameters by touching the „Operating parameters“ icon.

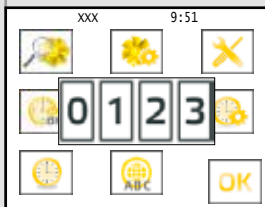

It is necessary to provide a password. This will remain valid for 30 min. After 30 minutes it is necessary to retype the password in order to continue making changes.

Password: 0213 (is shown as XXX near the time)

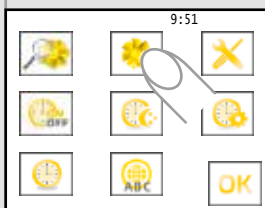

Now you have to select „Operating parameters“ again.

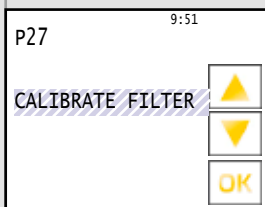

### P 27 Calibrate filter

Calibrating the pressure loss at the unclogged filter. The calibrated value corresponds to 0% clogging.

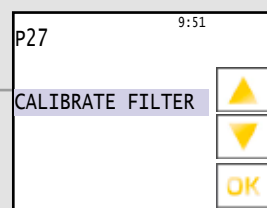

The entire ventilation system has to be complete in order to execute the filter calibration. By touching the icon „▲“, the unit switches to the calibration mode. Display flashes „CALIBRATE FILTER“.

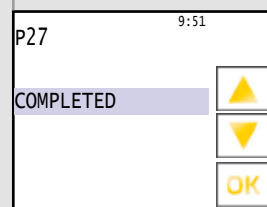

After calibration, the display shows „COMPLETED“.

